

Mint & Machine

実物大の型紙

MM007-Women's Pajamas-M

※この型紙を使用した作品の製作・販売は自由ですが、その際の責任等は一切負いかねますので予めご了承ください。

©かたやまゆうこ

型紙貼り合わせ 完成図

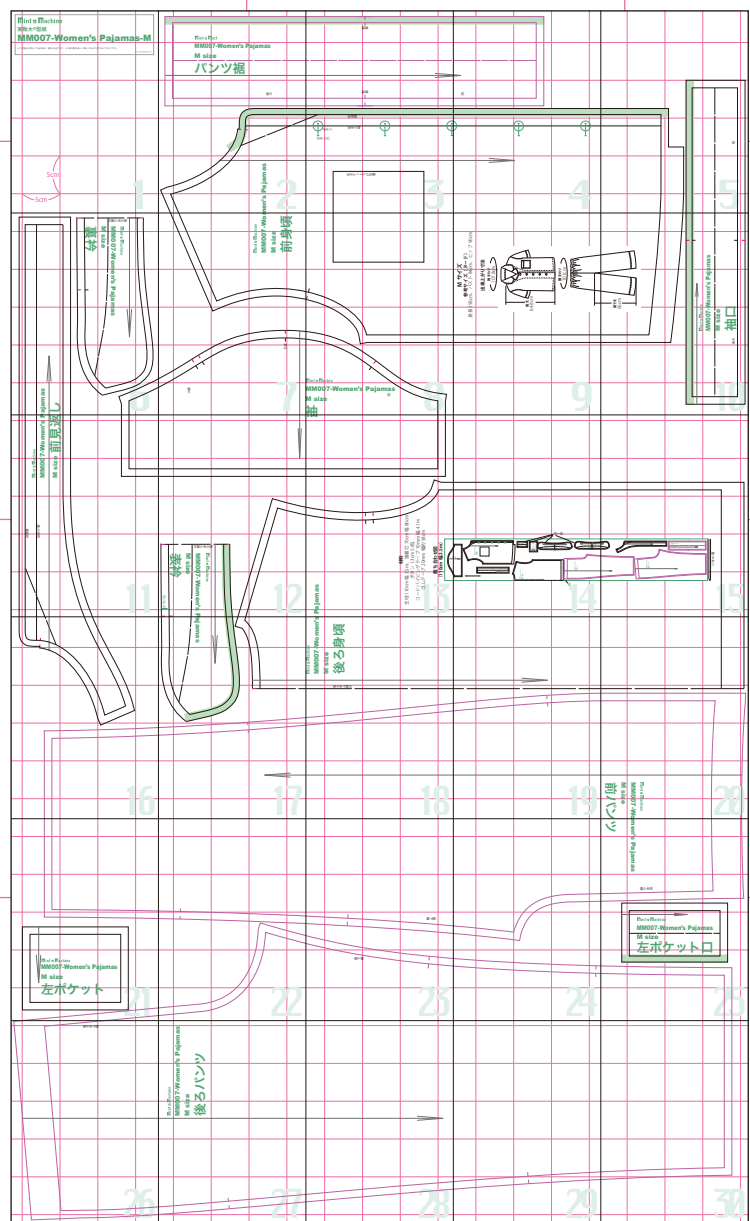

5cm

5cm

Mint & Mact

MM007-Women's Pajamas

M size

パンツ裾

後ろ

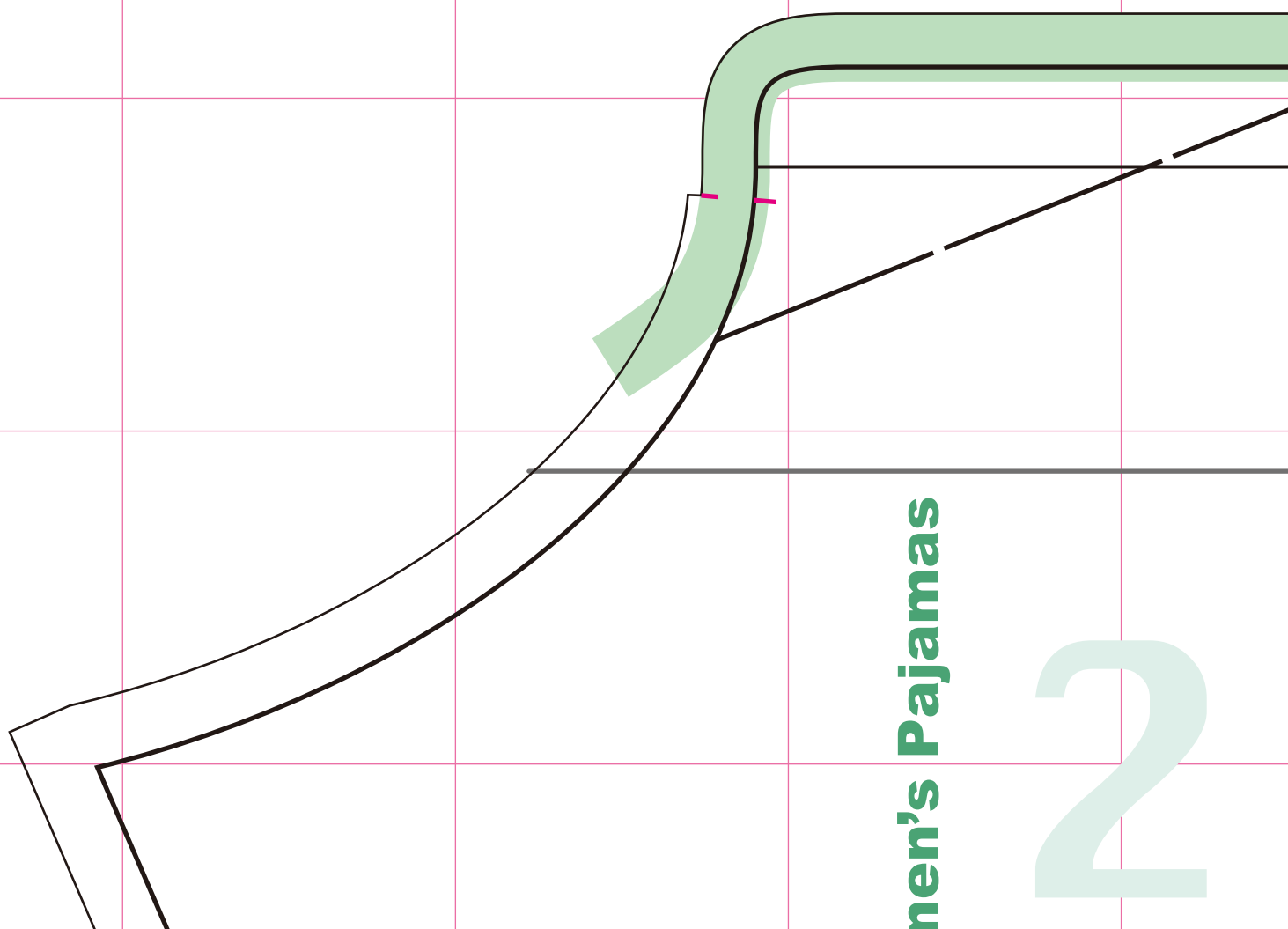

Women's Pajamas

2

脇線

脇線

前端線

前中心線

ボタン

ボタン穴

左ポケットつけ位置

3

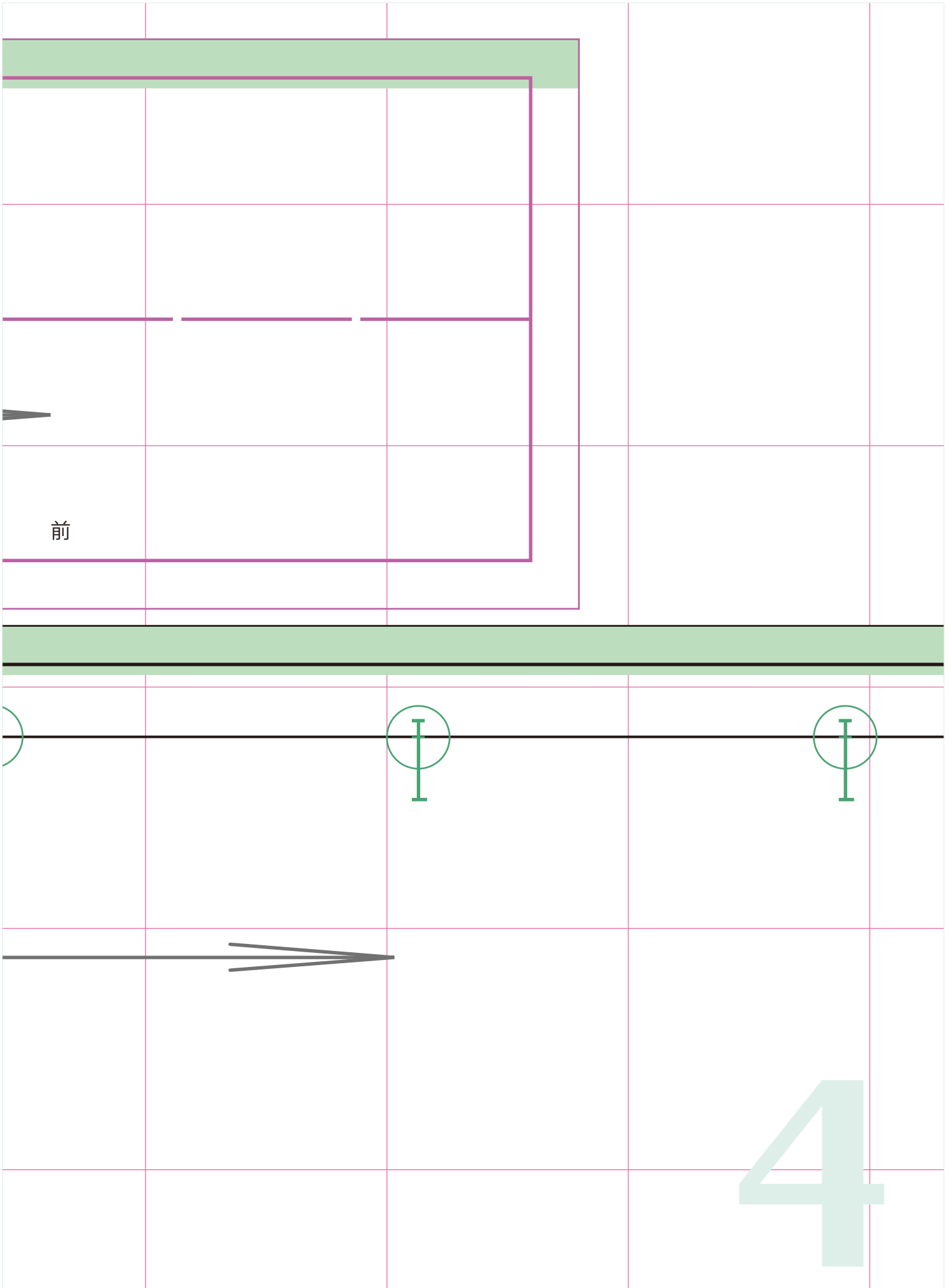

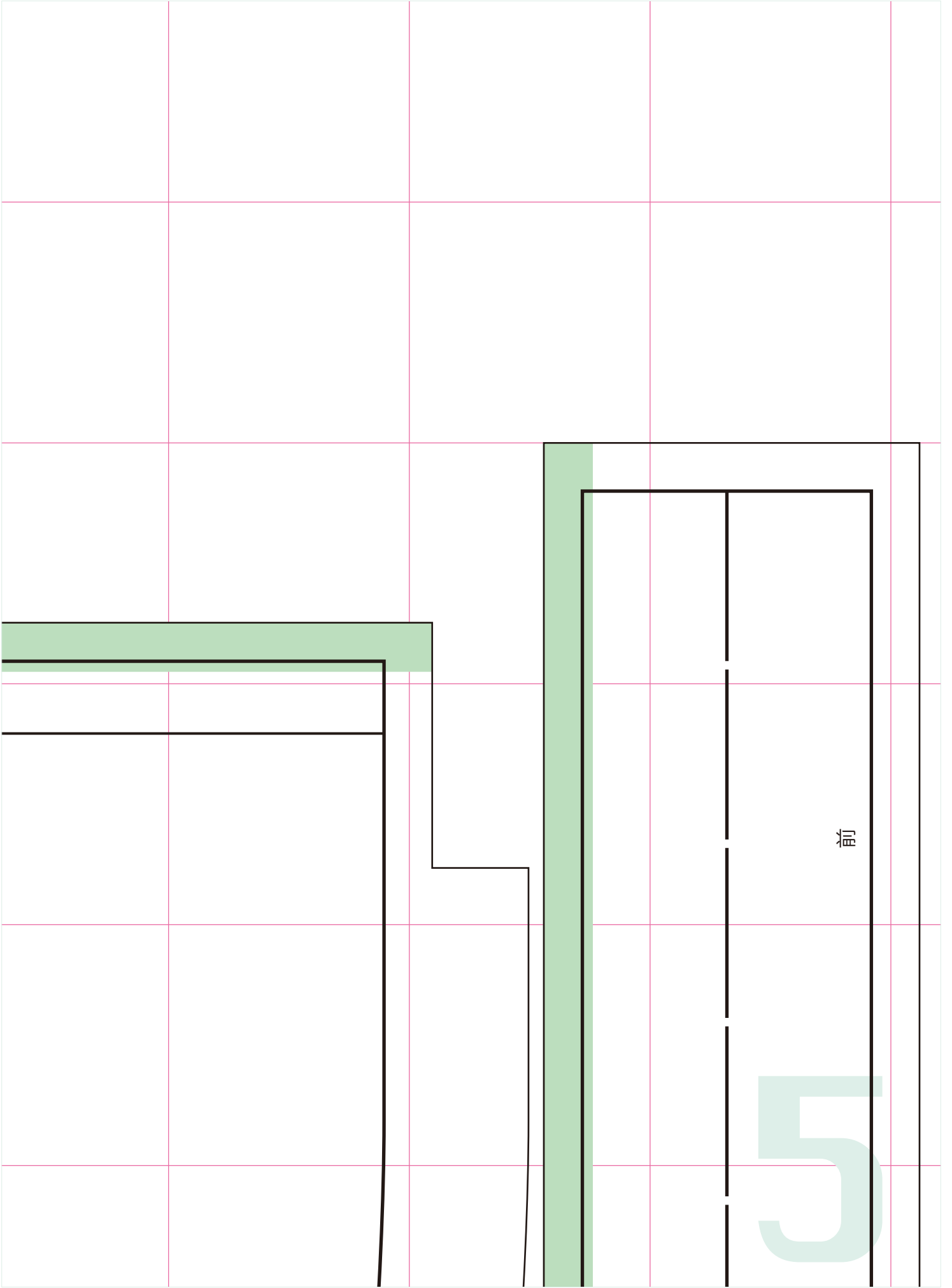

前

5

9



後ろ中心線を

Mint & Machine

MM007-Women's Pajamas

M size

裏衿

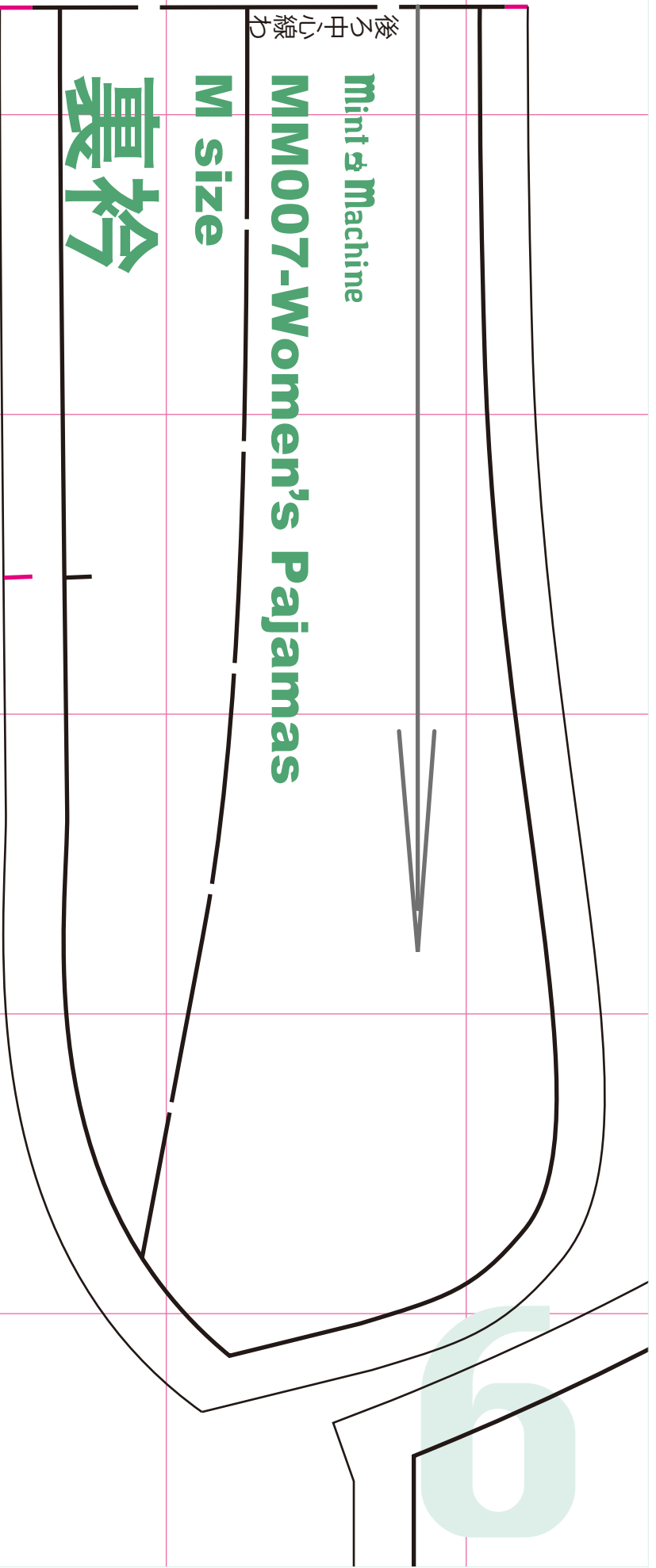

pajamas

7

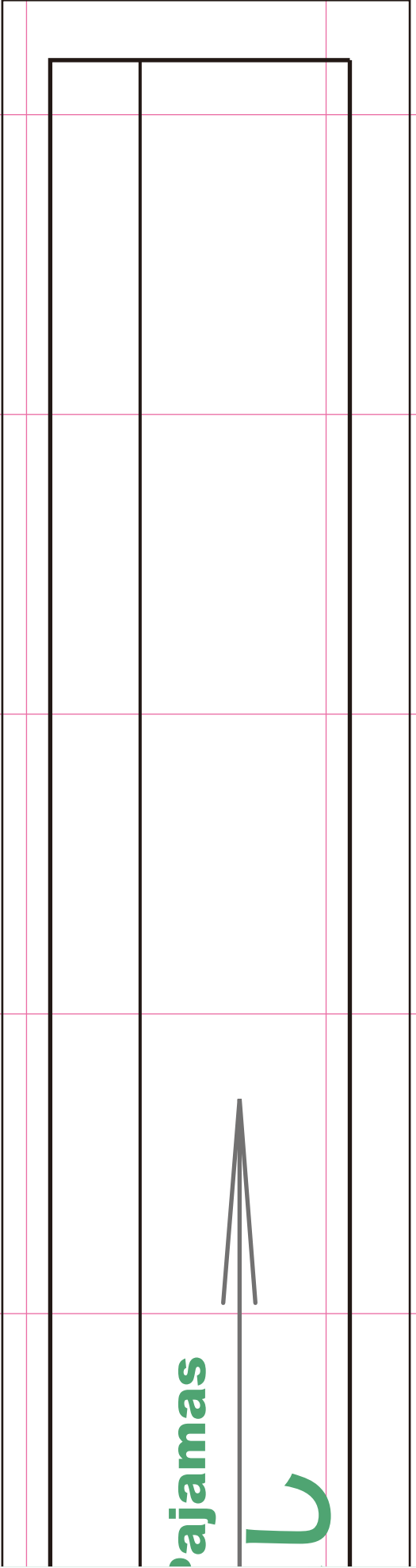

Mint & Machine
MM007-Wor
M size
前身頃

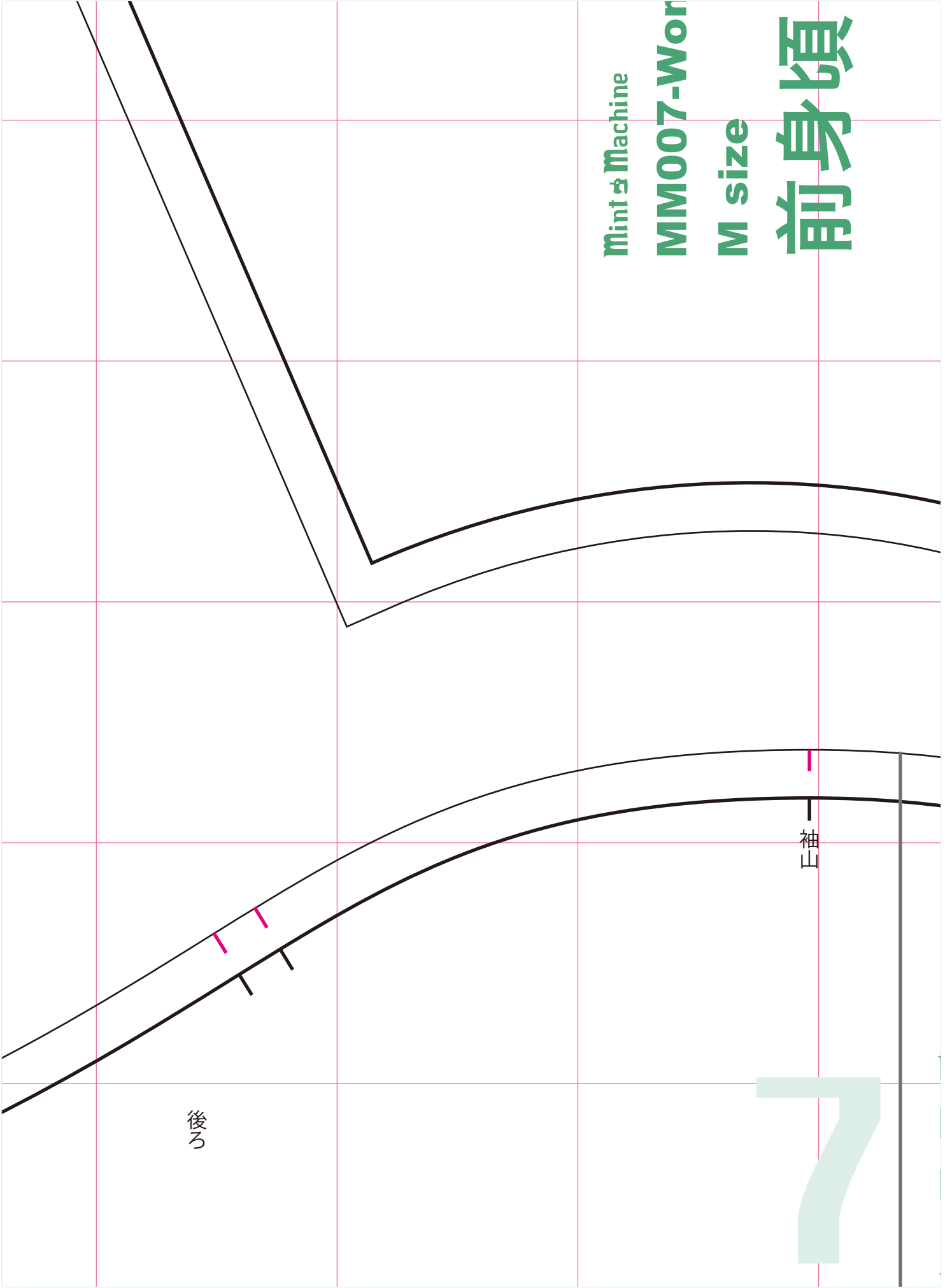

後ろ

袖止

7

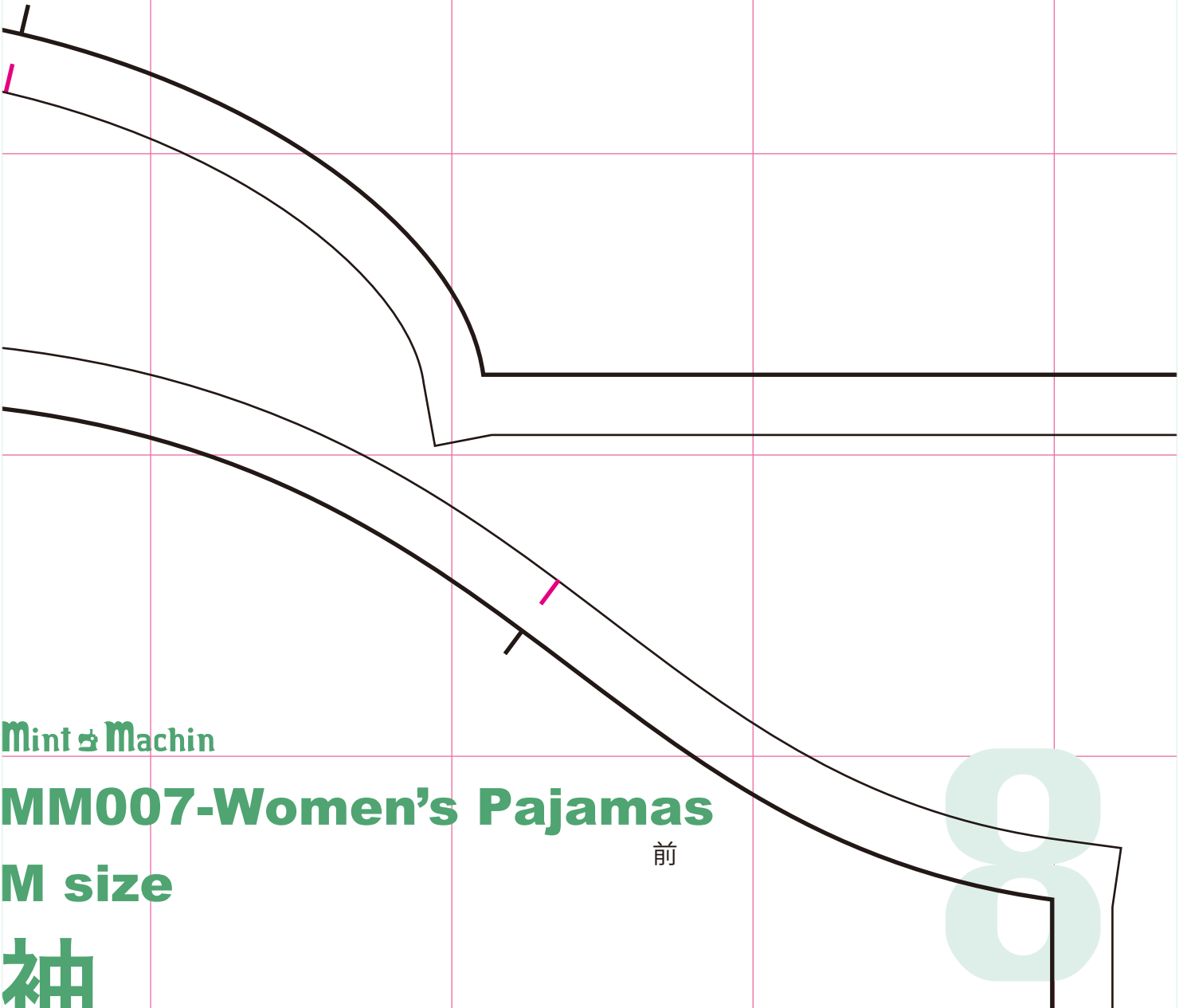

Mint & Machin

MM007-Women's Pajamas

M size

袖

前



Mサイズ

参考サイズ (ヌード)

身長 158cm、バスト 84cm、ヒップ 90cm

出来上がり寸法

胸まわり

107.8cm

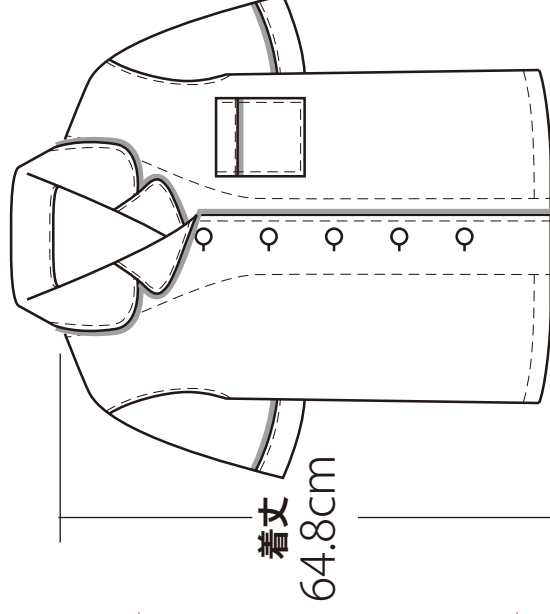

着丈

64.8cm

腰まわり

101cm

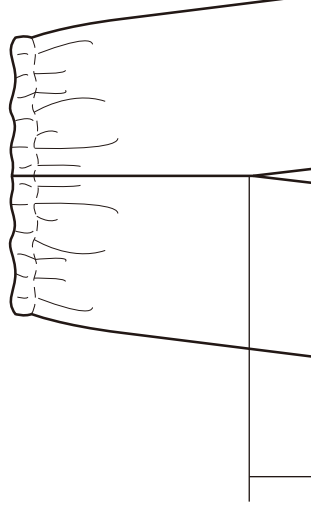

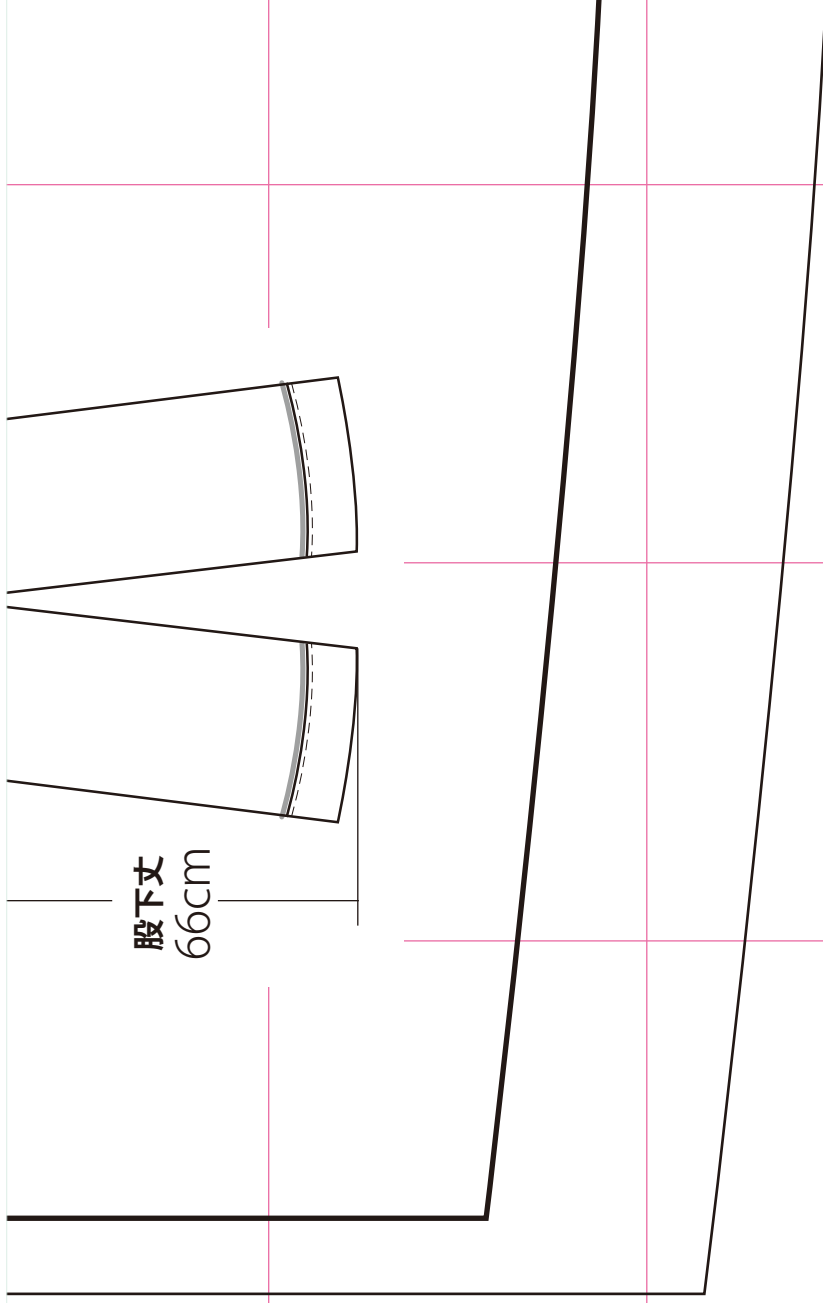

股下丈
66cm

Mint & Machin

MM007-Women's Pajamas

M size

袖口

後ろ

10

縫製機

Mint & Machine

MM007-Women's P

M size 前見返

裾中心線

11



12

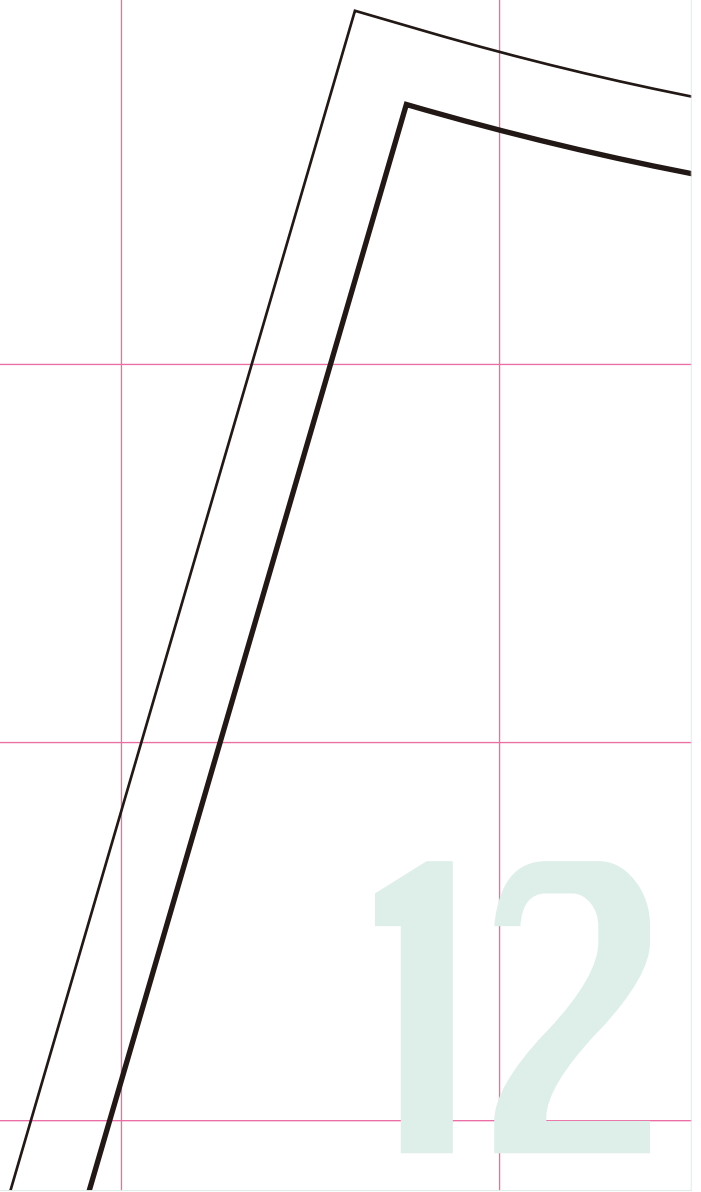

後ろ中心線
わ

Mint & Machine

MM007-Women's P

M size

表衿

切り込み

Pajamas

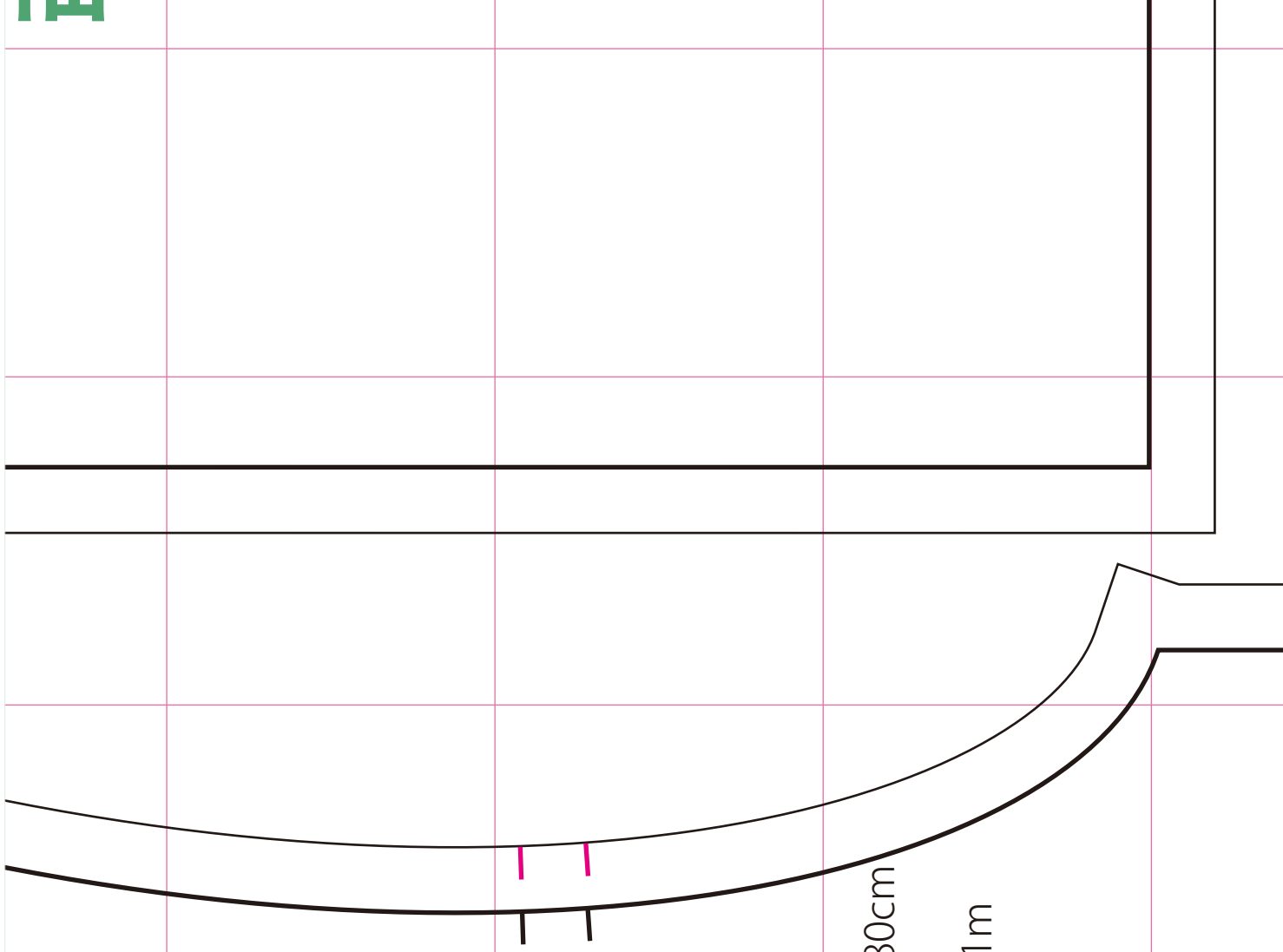

材料

生地 110cm 幅 3.5m、接着芯 70cm 幅 80cm
ボタン 1.3cm 5 個、
コードパイピングテープ 10mm 幅 4.1m
ゴムテープ 20mm 幅約 58cm

裁ち合わせ図
(110cm 幅 3.5m)

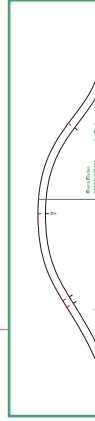

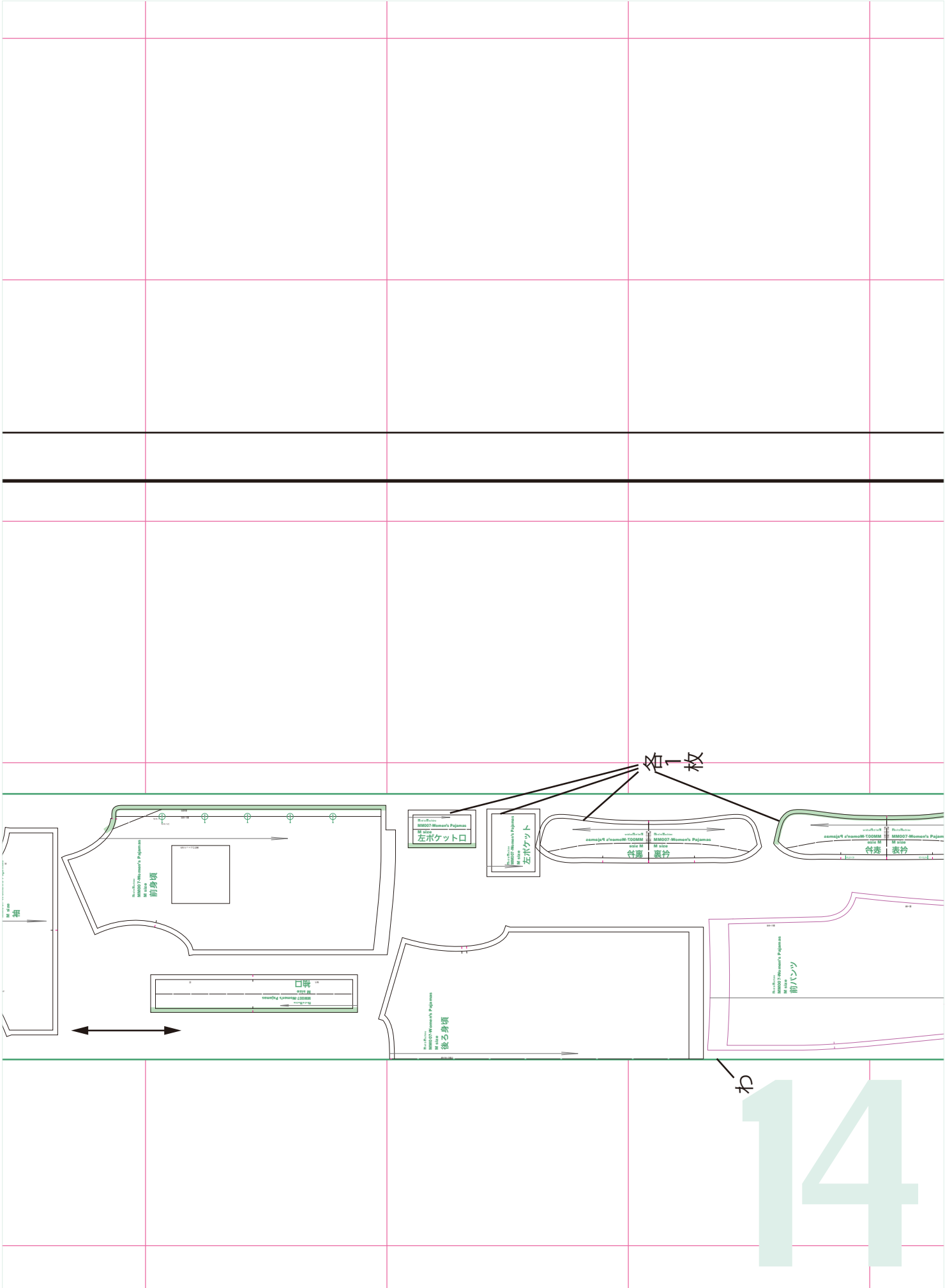

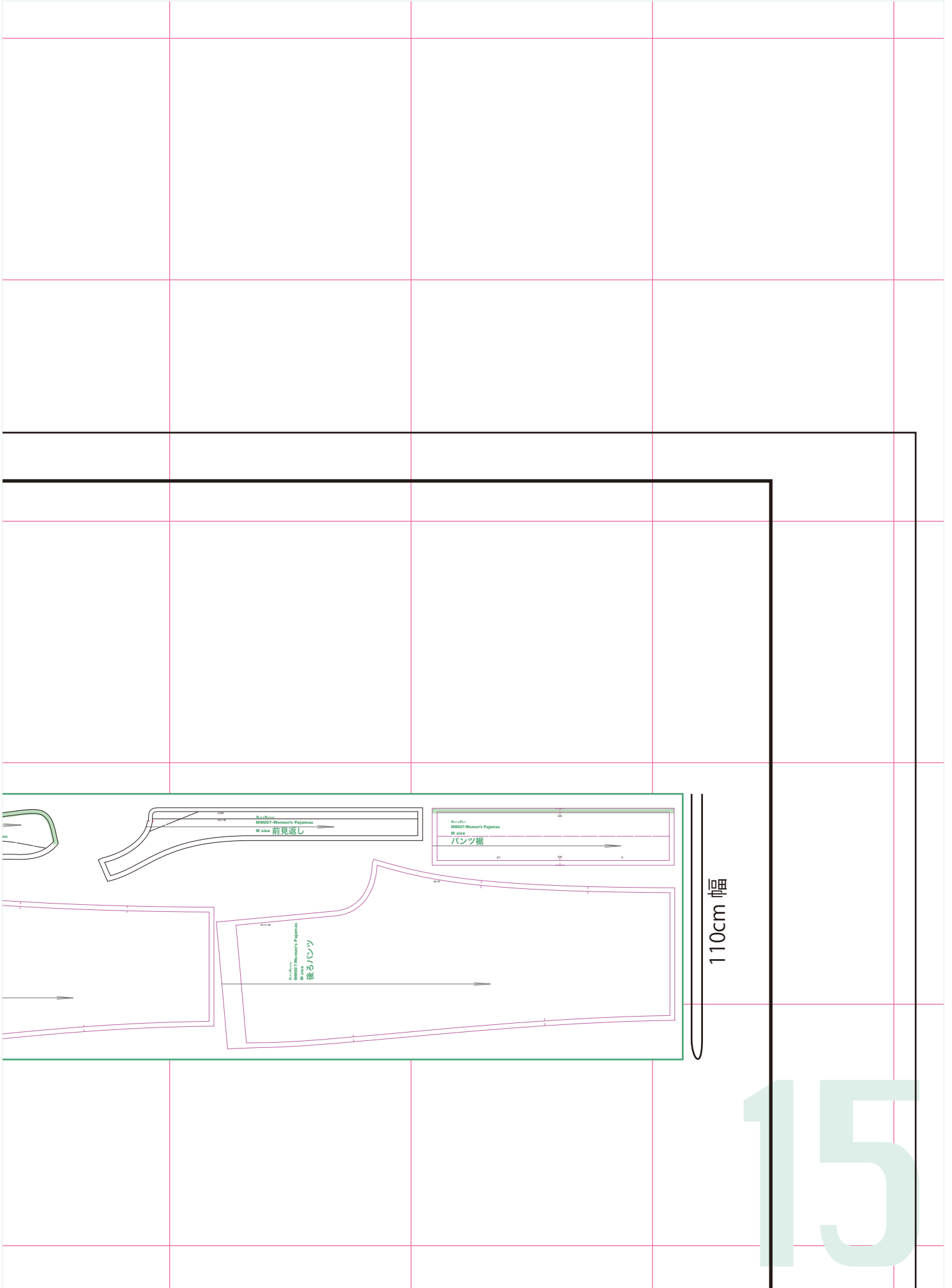

110cm 幅

15

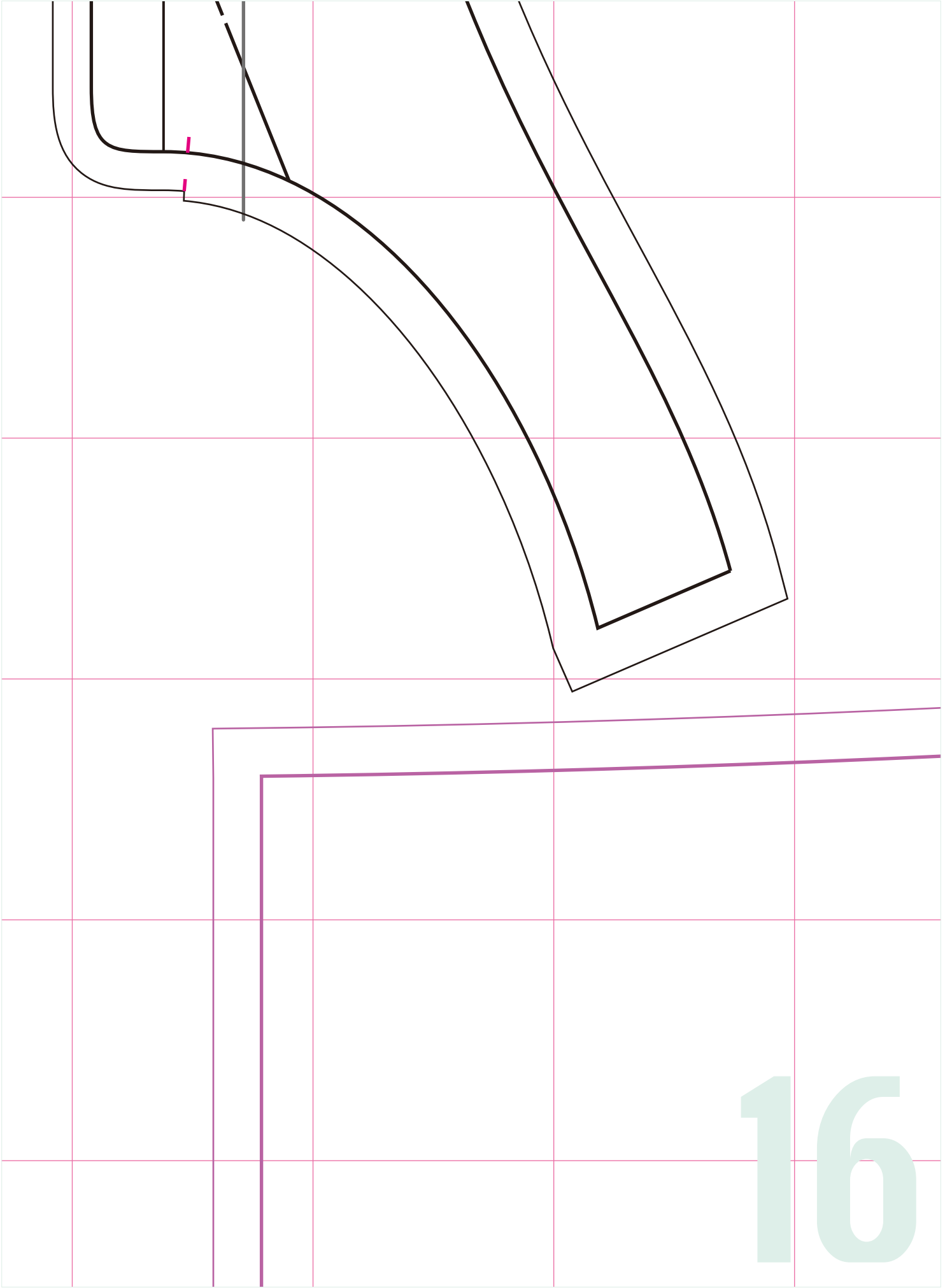

ajamas



17

Mint & Machine

MM007-Women's

M size

後ろ身頃

後ろ中心線

18

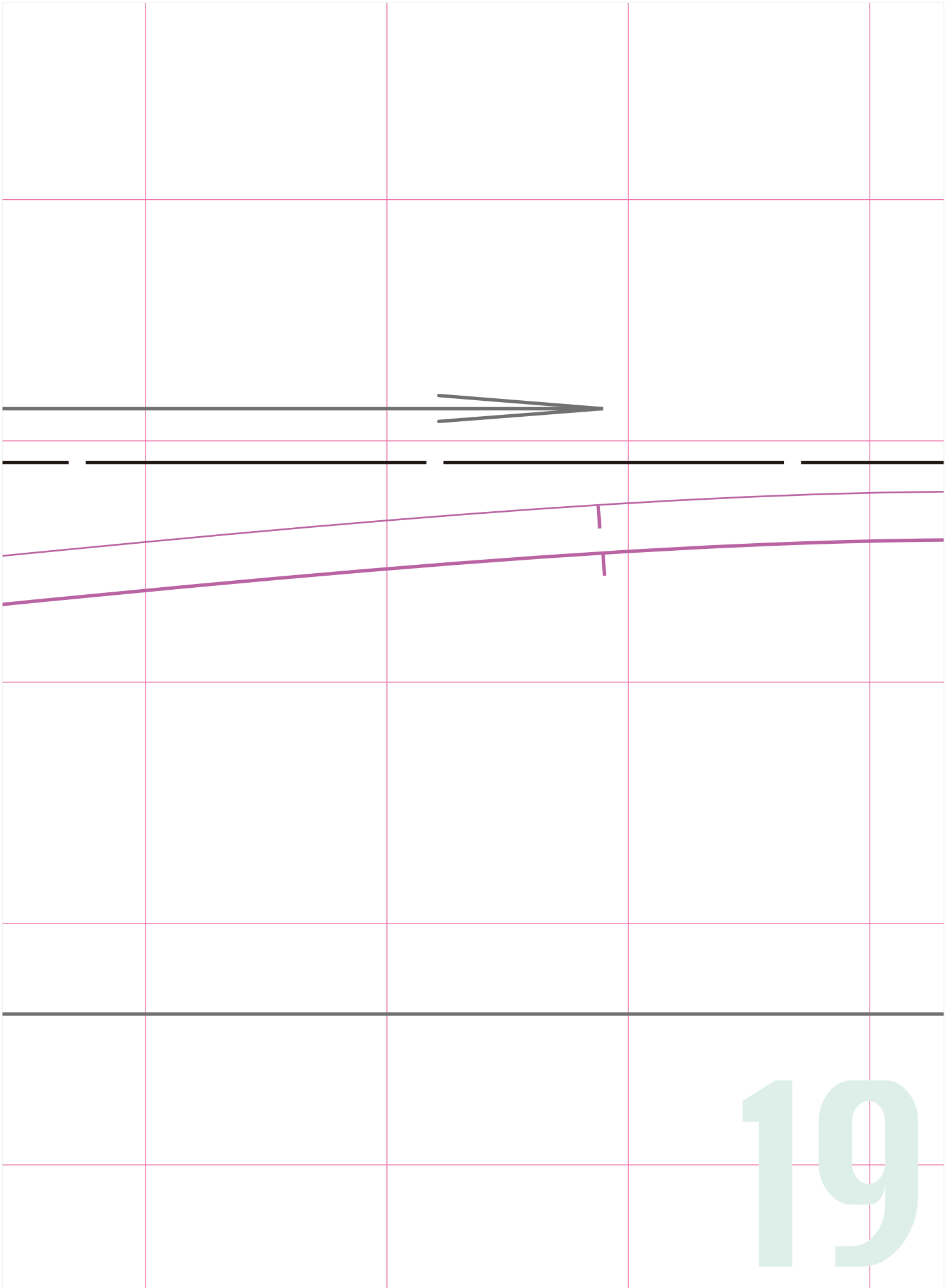

20

Mint & Machine

MM007-W0

M size

前ペン

Mint & Machine

MM007-Women's Pajamas

M size

左ポケット

21

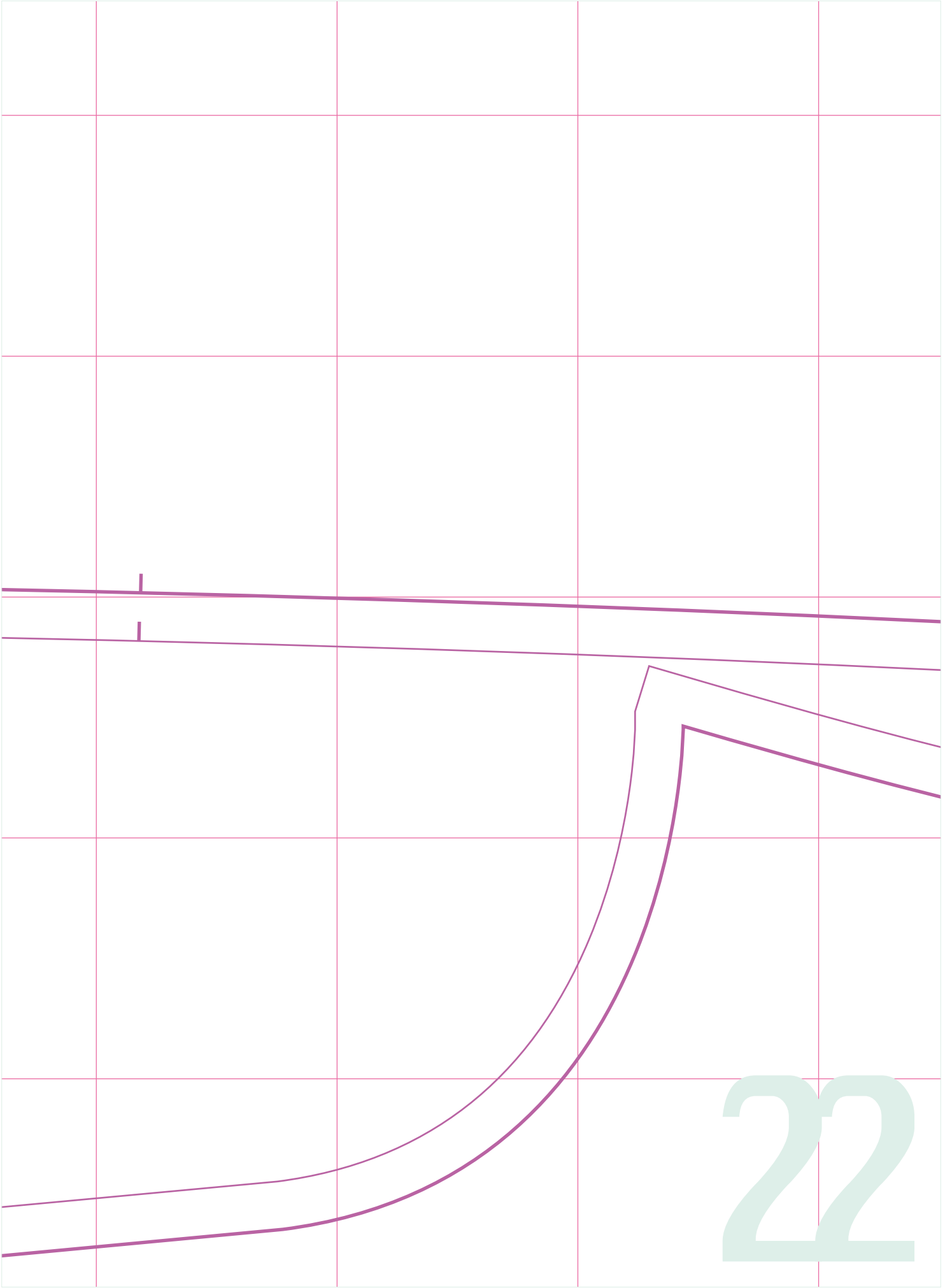

22

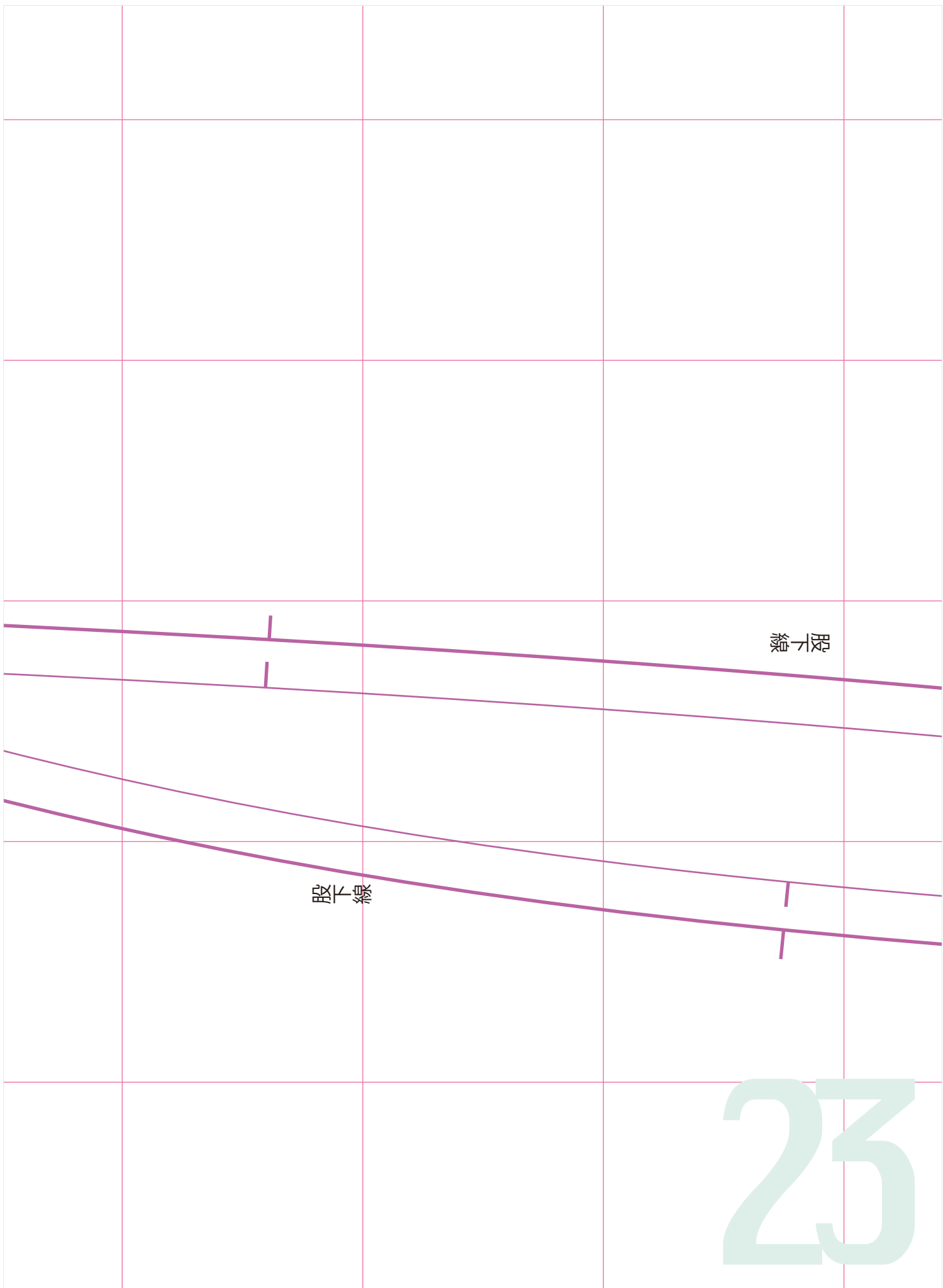

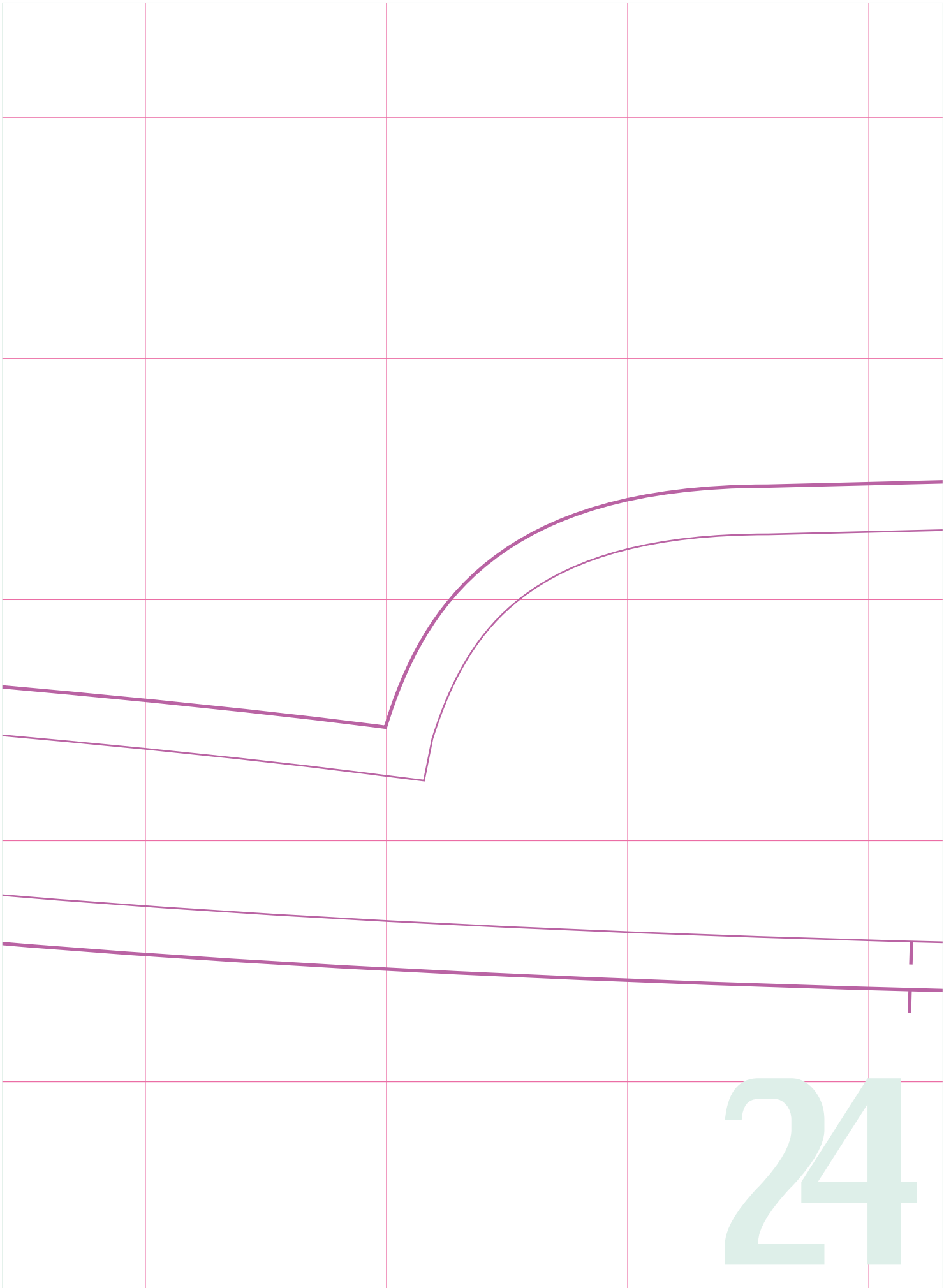



Women's Pajamas

前身線

Mint & Machine

MM007-Women's Pajamas

M size

左ポケット口

25

後の中心線

Mint & Machine

MM007-Women's Pajamas

M size

後ろパンツ

27

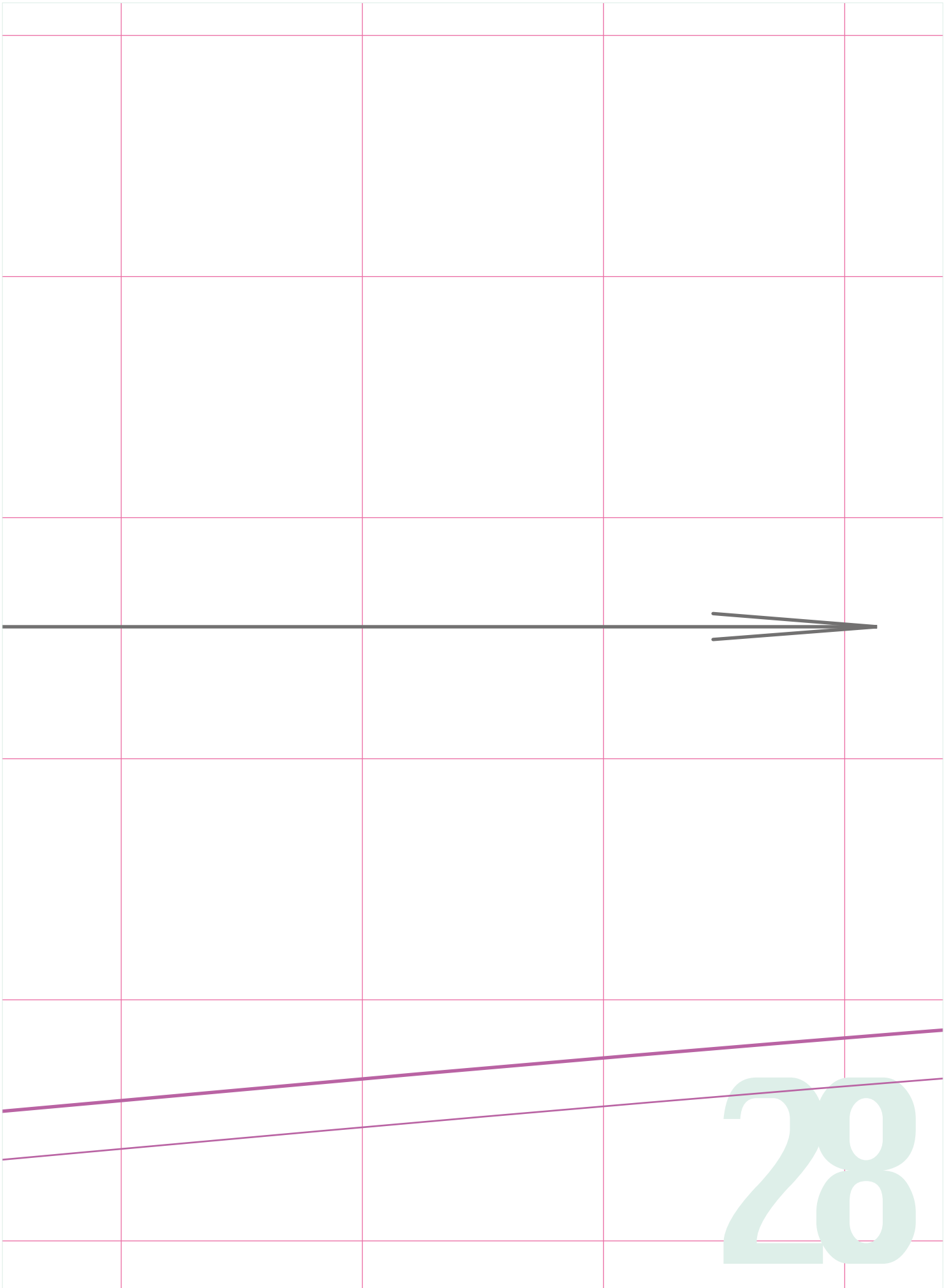

28

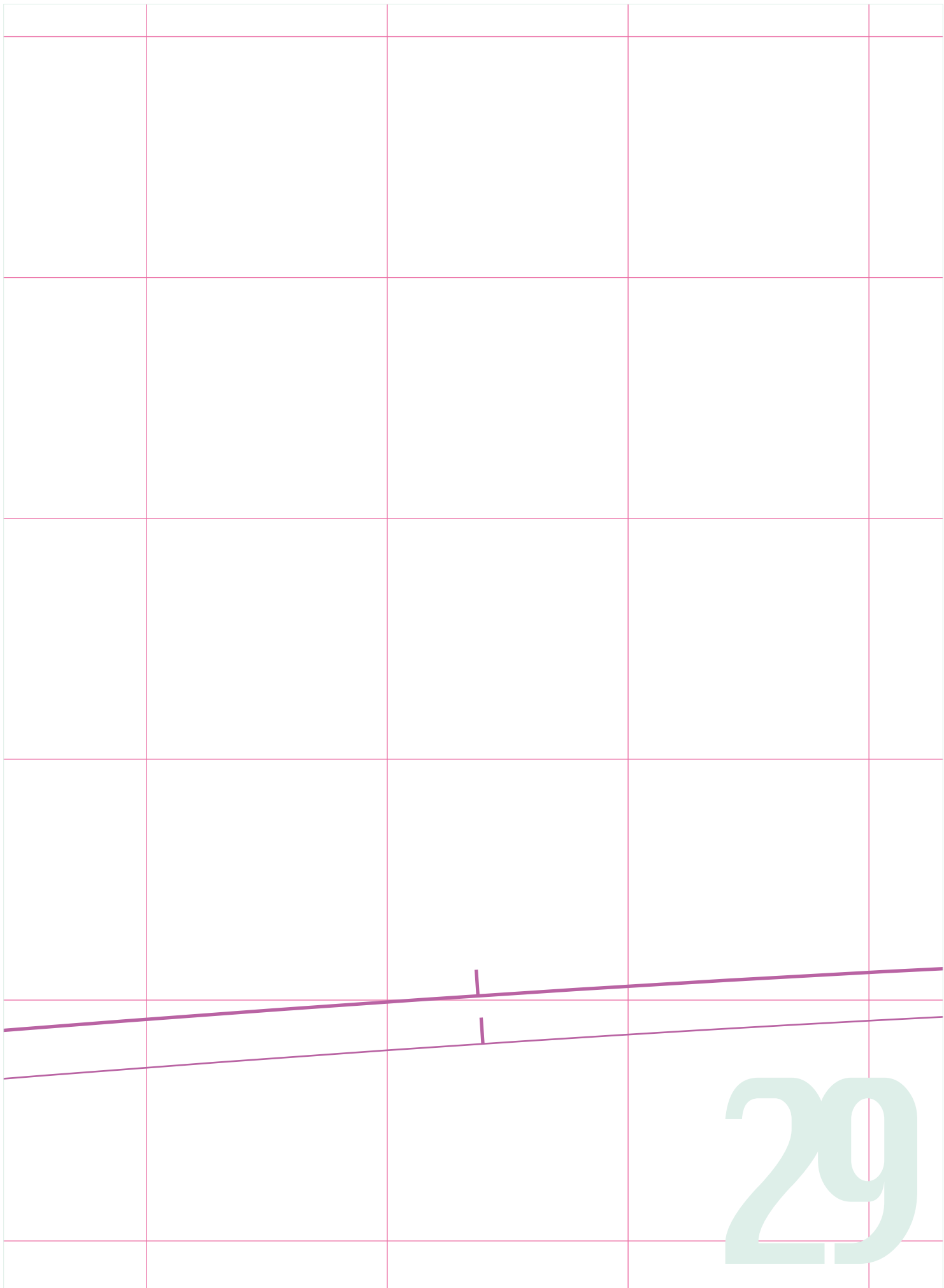

29

